

Mini Masterclass

NÄHEN MIT MUSSELIN FÜR KIDS

Alle Rechte bei ©Edition Michael Fischer GmbH, Igling

Tunika-Kleid

Die Naht- und Saumzugaben sind nicht enthalten.



Kontrollquadrat
1cm x 1cm

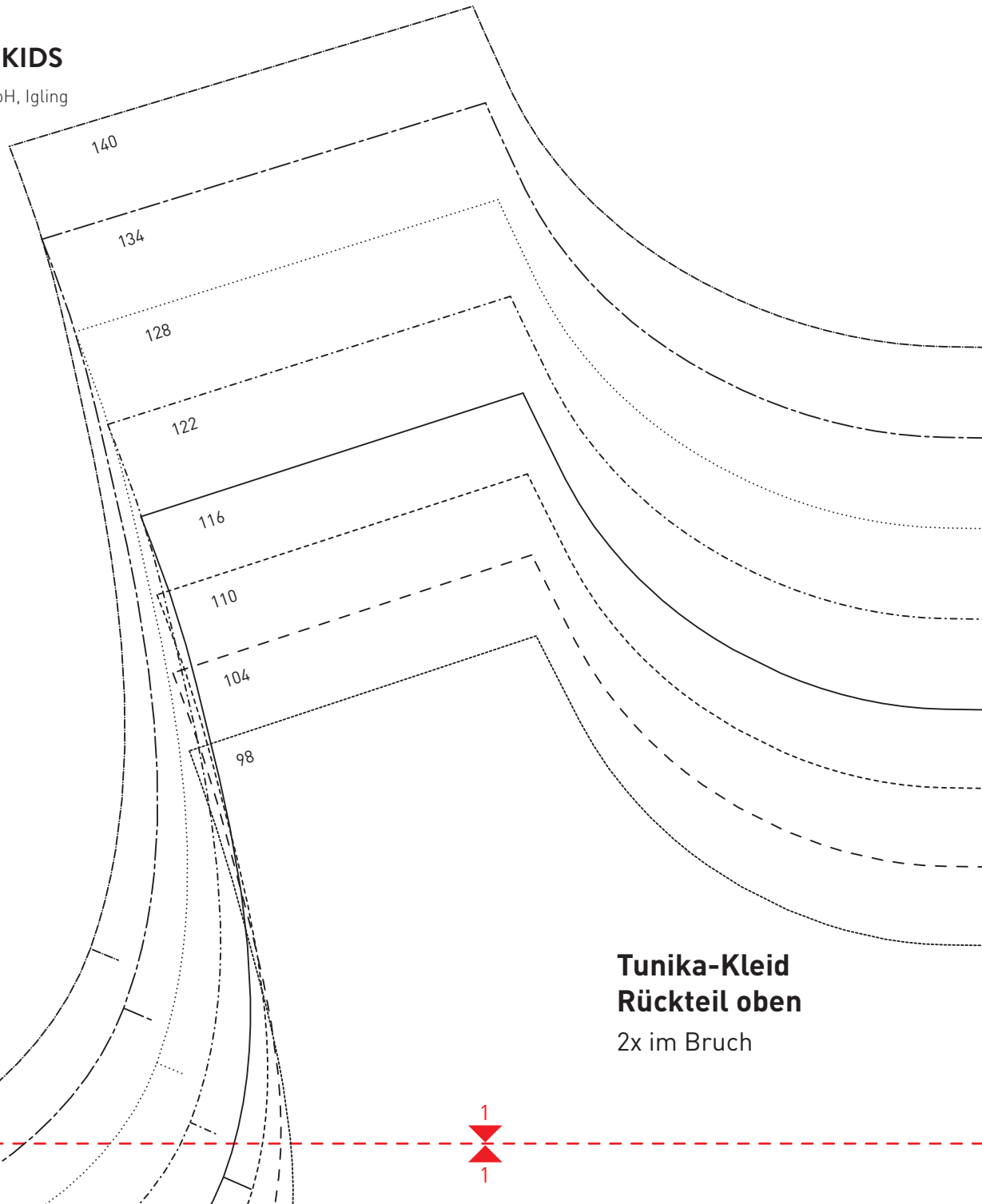

Tunika-Kleid
Rückteil oben

2x im Bruch



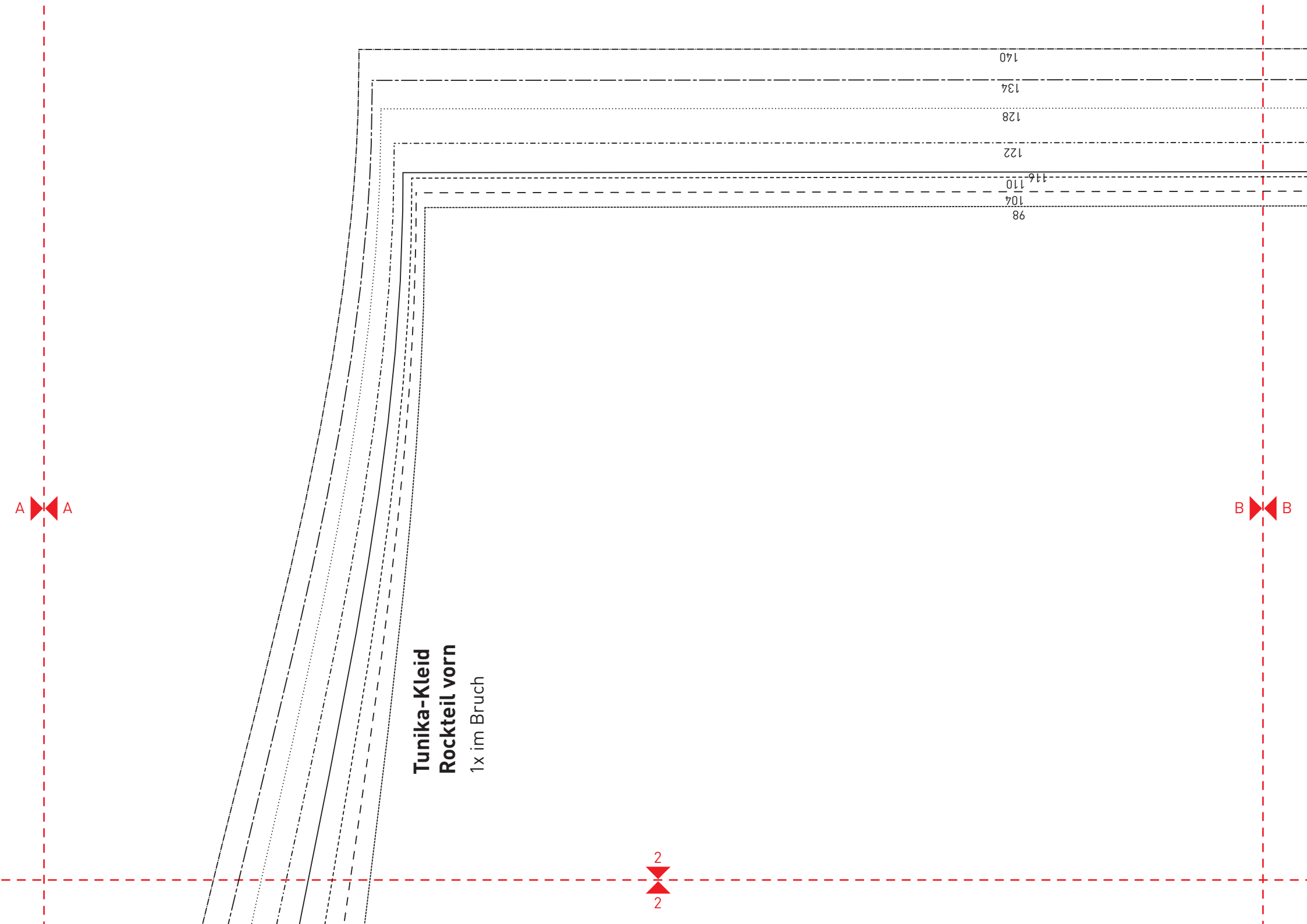

Tunika - Kleid
Rockteil vorn
1x im Bruch

140
134
128
122
116
110
104
98

A A

B B

2
2

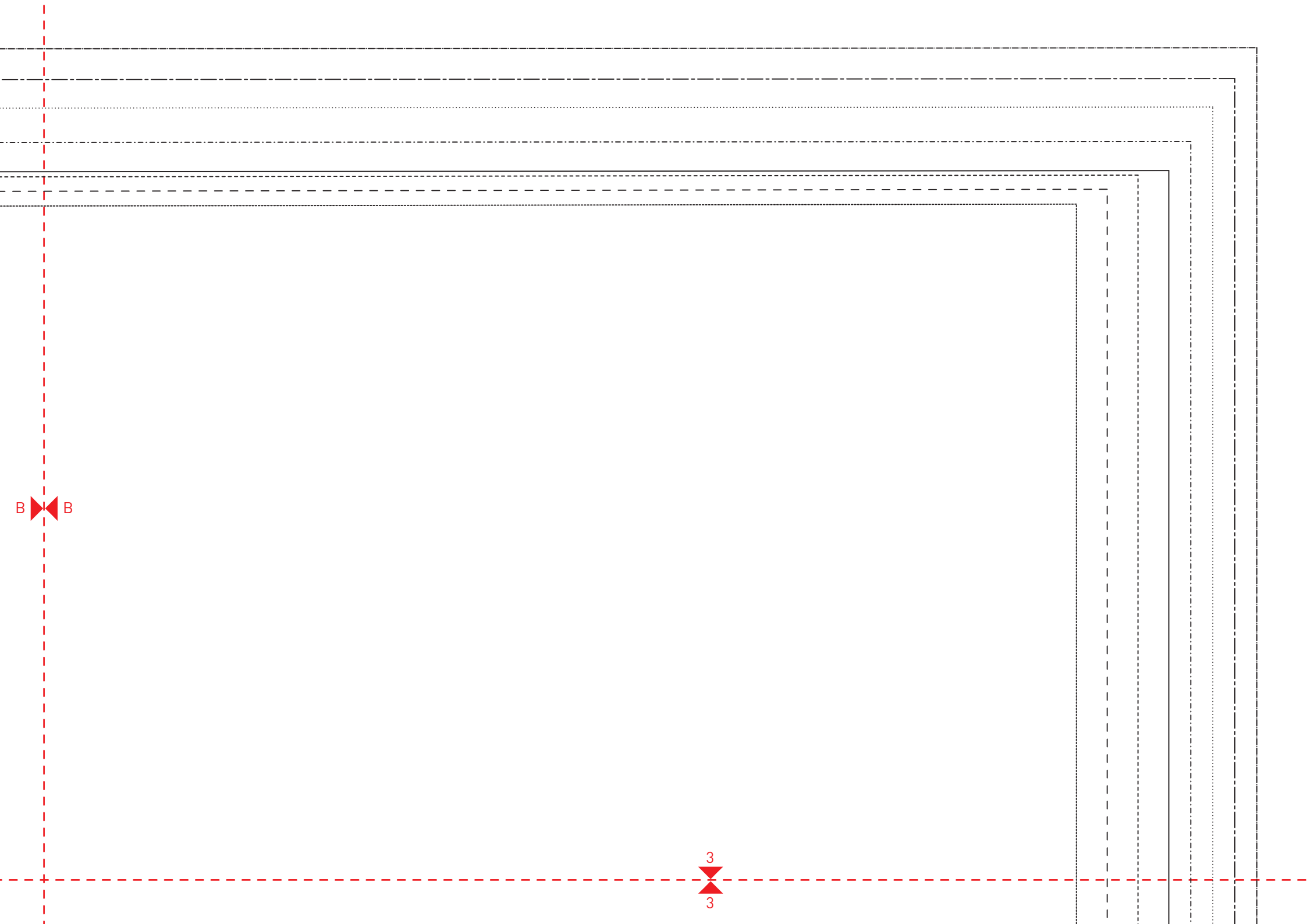

1
1

C C

HM/BRUCH/FDL

4
4

98
104
110
116
122
128
134
140

140

134

128

122

116

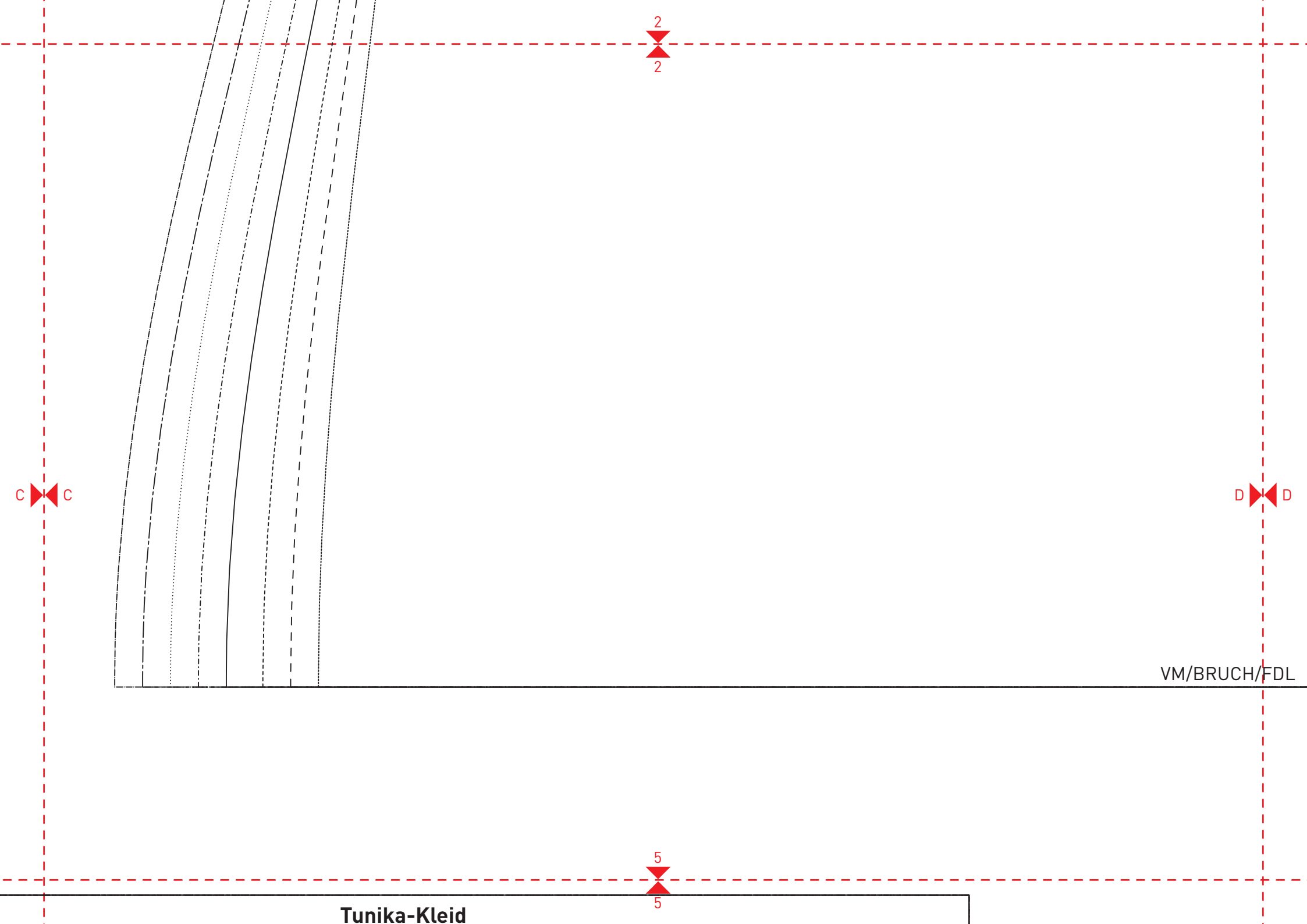

Tunika-Kleid

VM/BRUCH/FDL

C

D

2

2

5

5

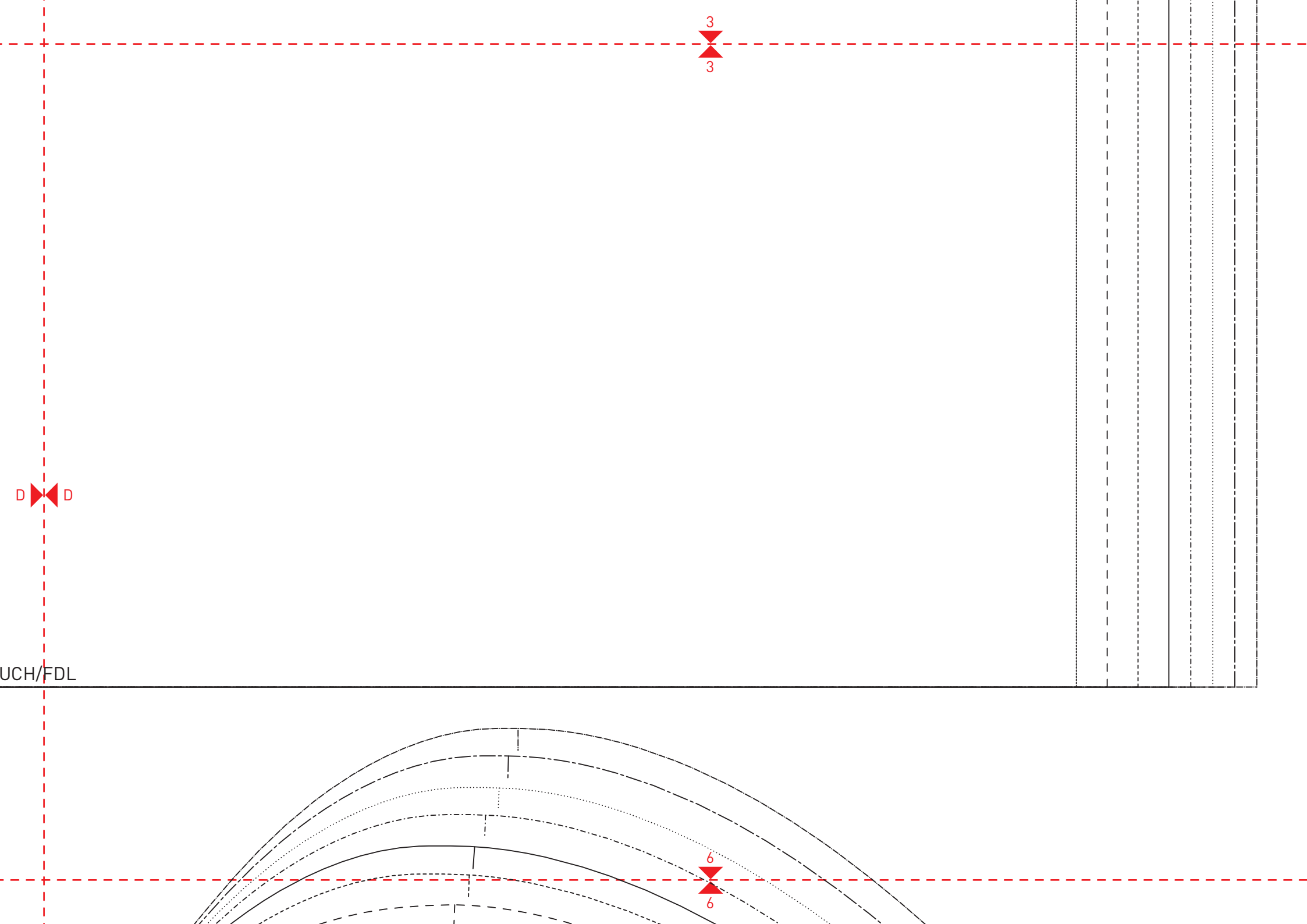

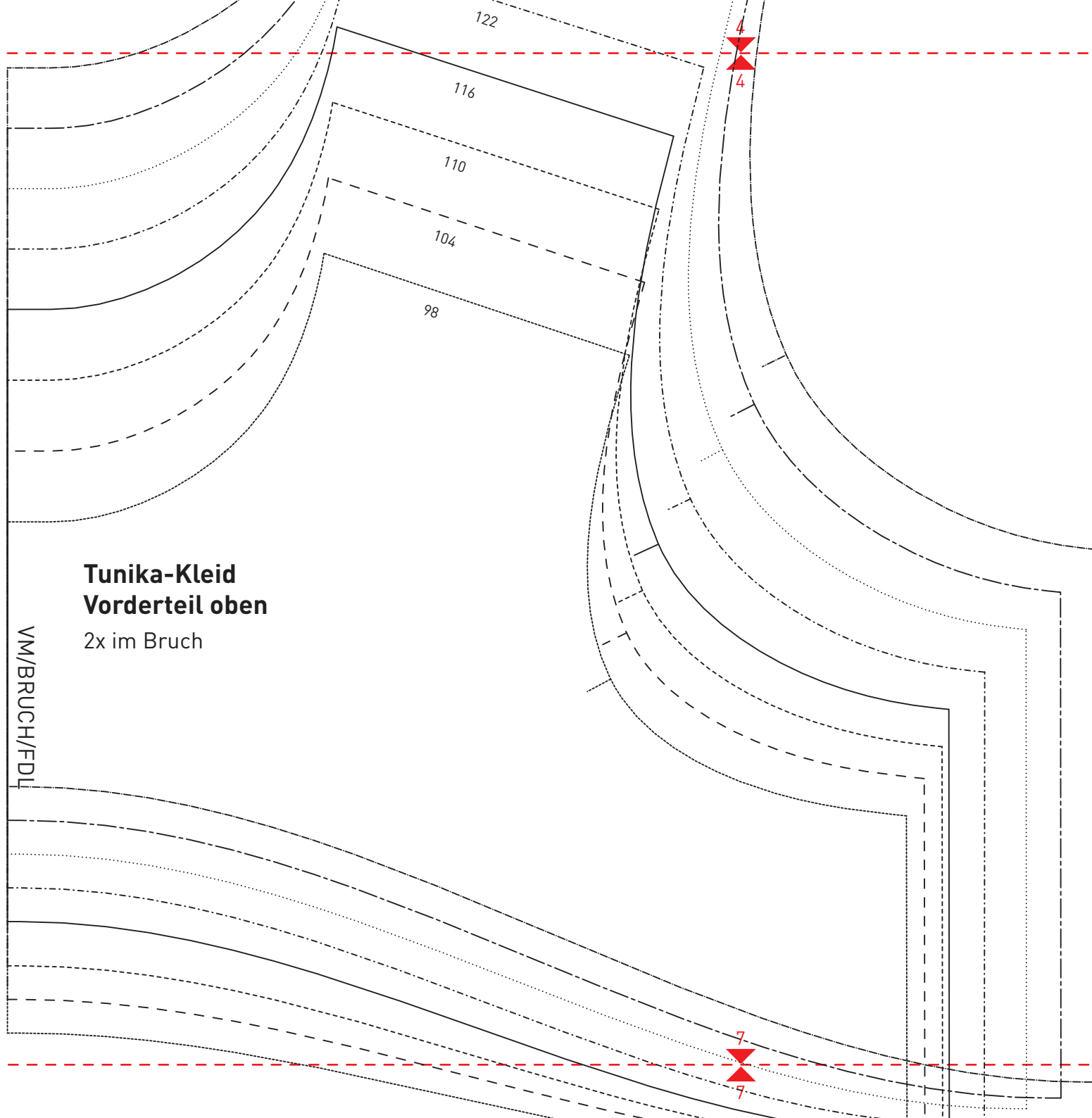

**Tunika-Kleid
Vorderteil oben**

2x im Bruch

VM/BRUCH/FDL

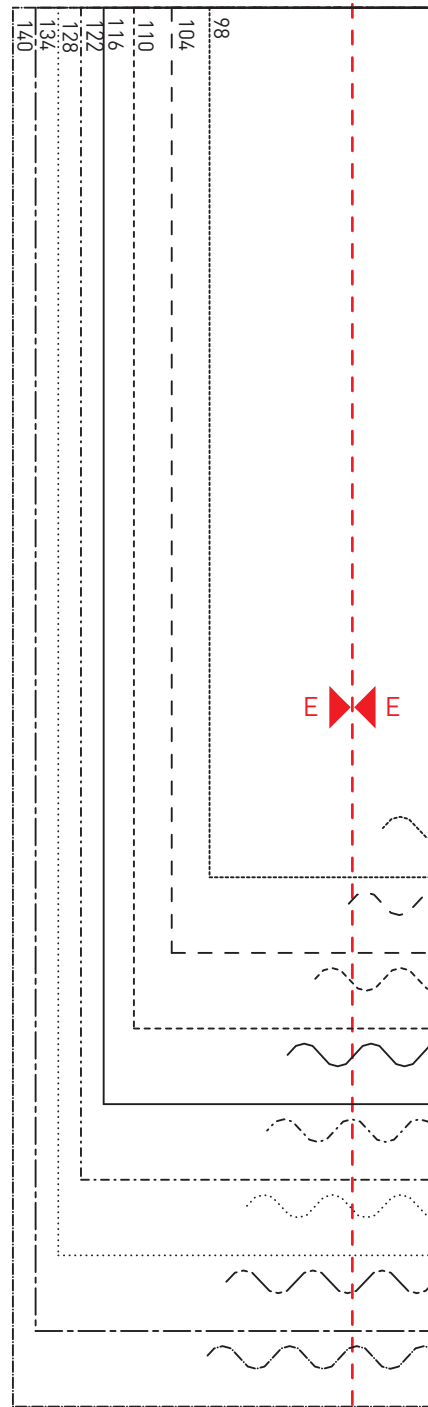

E

Tunika-Kleid Ärmelrüsche

2x im Bruch

5

5

E

E

BRUCH/FDL

F

F

98

104

110

116

122

128

8

8

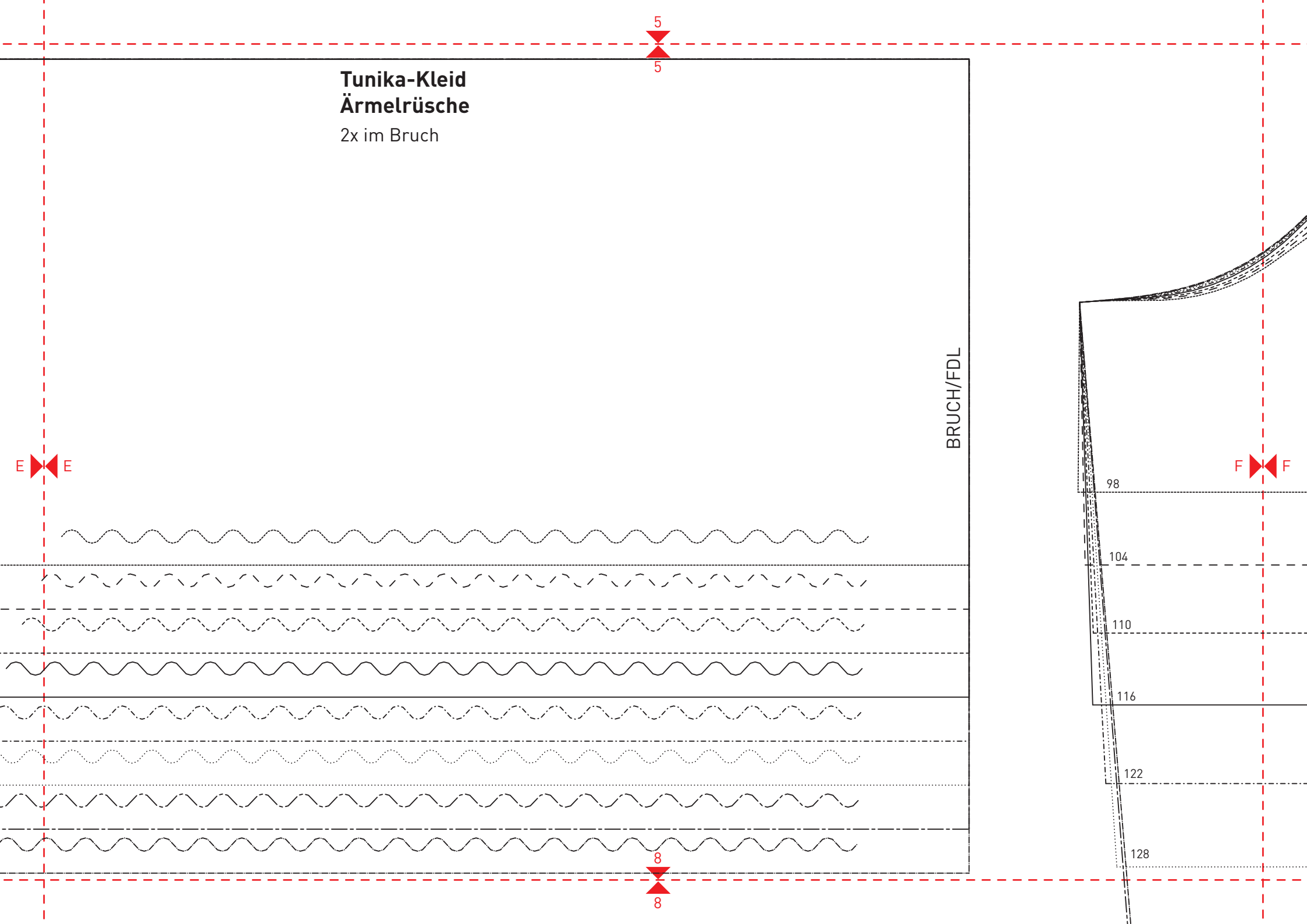

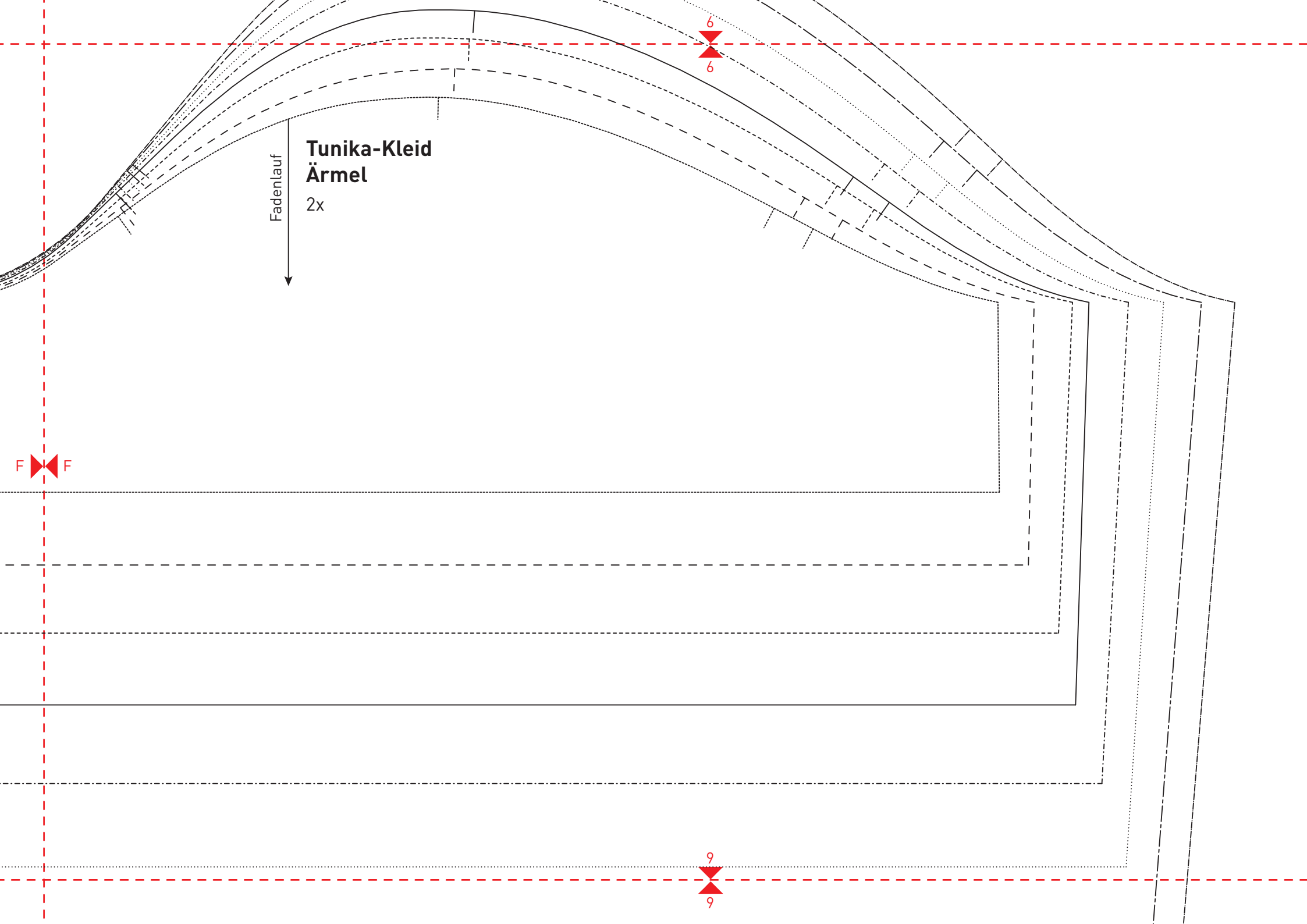

Tunika-Kleid
Ärmel

2x

Fadenlauf
↓

6
6

9
9

F
F

Tunika-Kleid
Rockteil hinten
1x im Bruch

10
10

G G

7
7

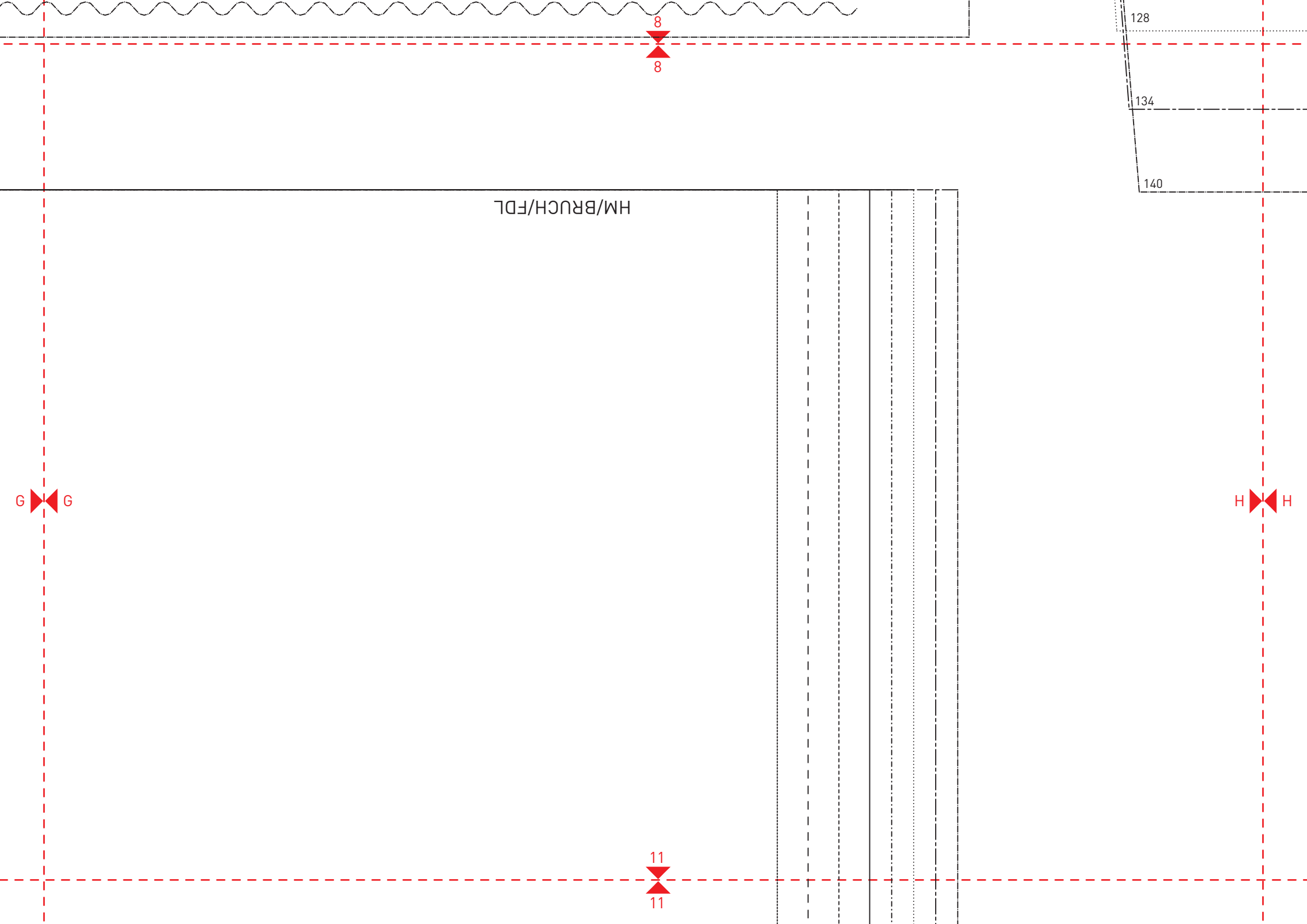

HM/BRUCH/FDL

8

8

128

134

140

G

G

H

H

11

11



10



10



98

104

110

116

122

128

134

140

13



13

