

Let's stay home

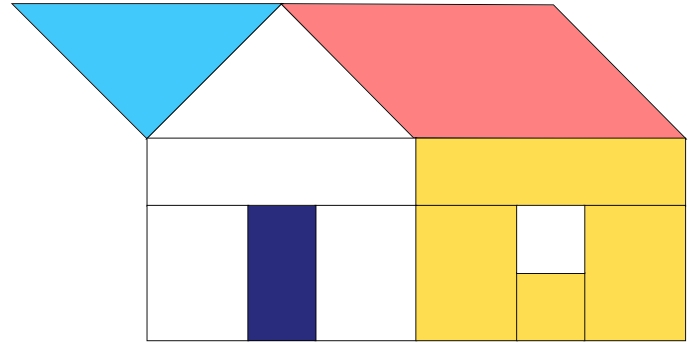

Templates

Block A

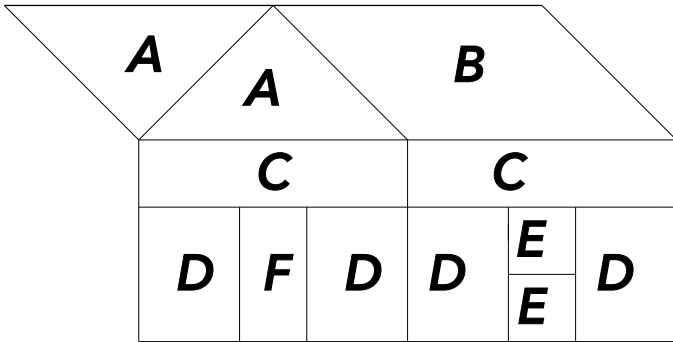
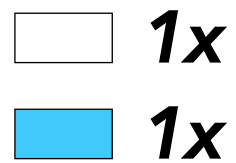
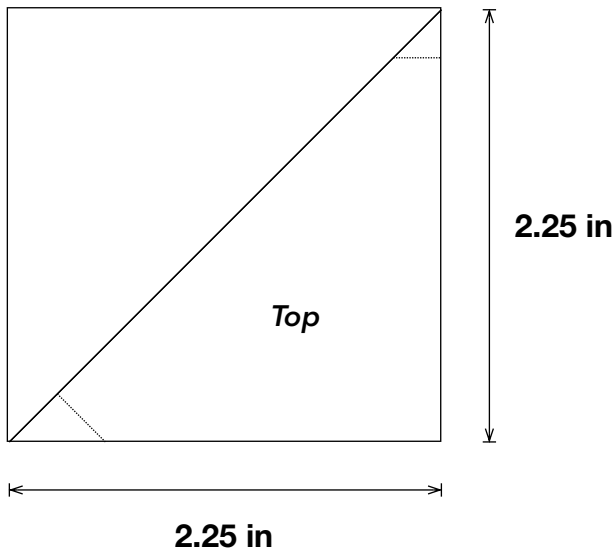

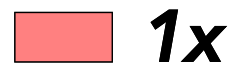
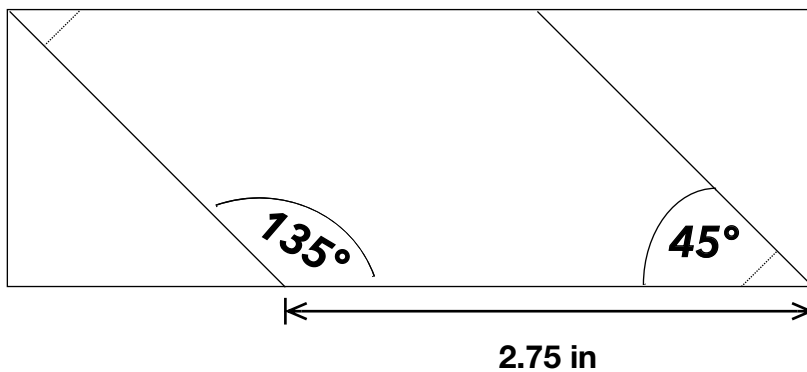

Block B



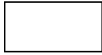

Block C



-  **1x**
-  **1x**

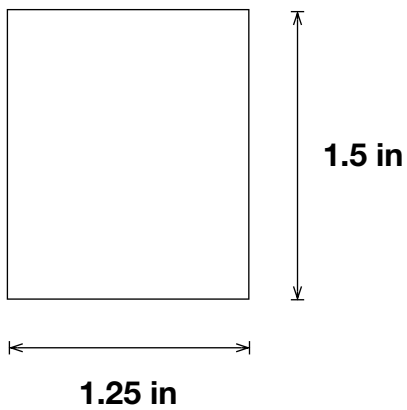

Block D

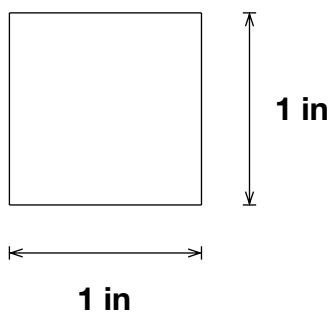

-  **2x**
-  **2x**

Block E

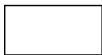

-  **1x**
-  **1x**

Block F

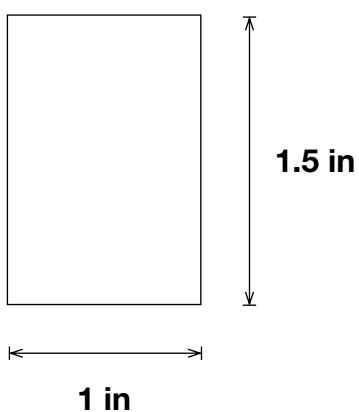

-  **1x**

Finished Row

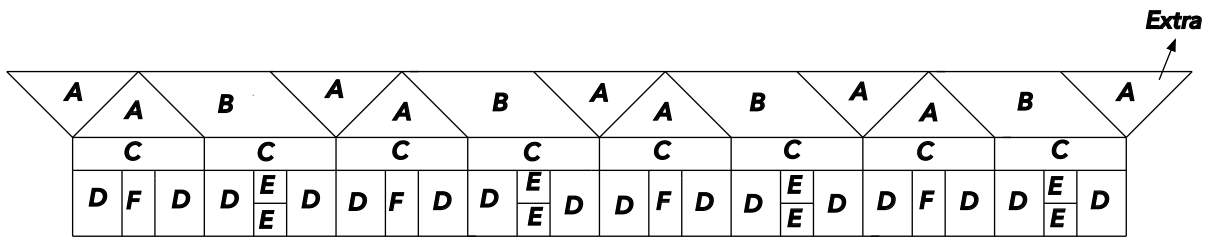

Step 1

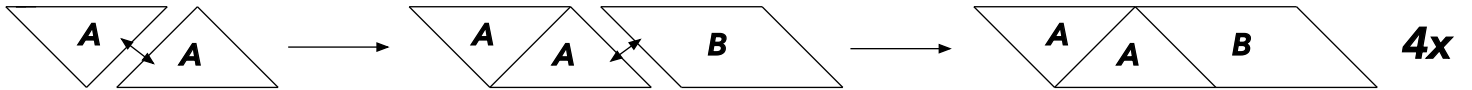

Step 2

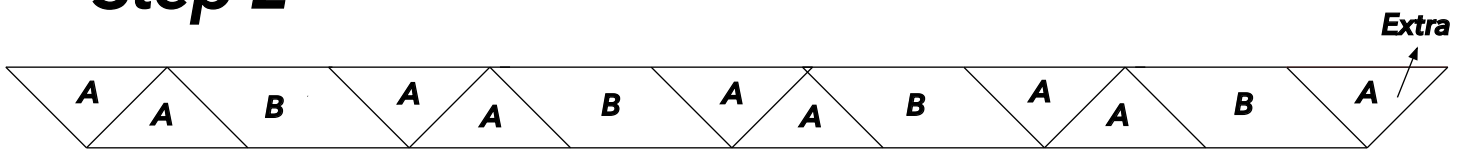

Step 3

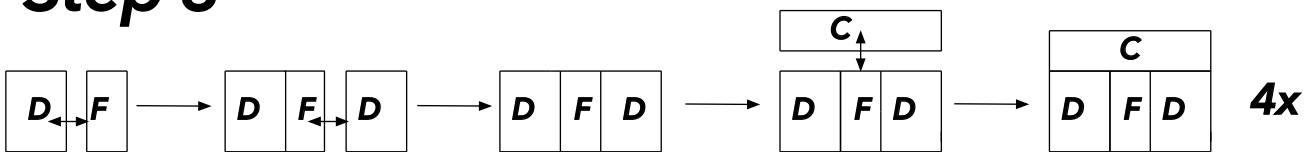

Step 4

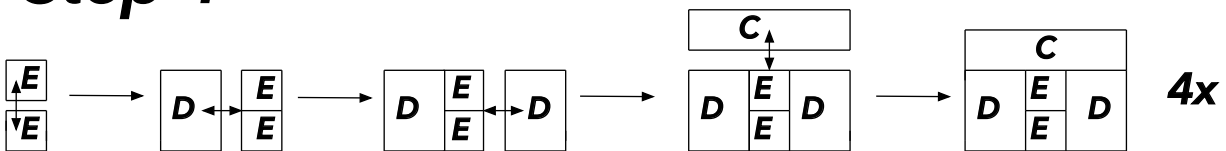

Step 5

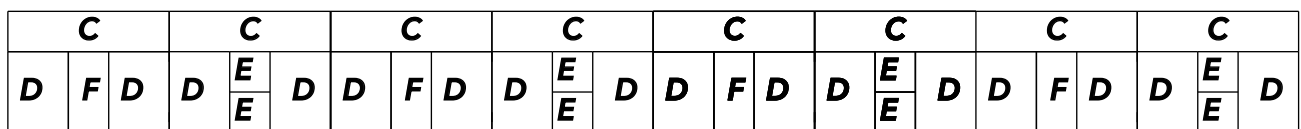

Step 6

